

SPICE thermal model

BUK9515-60E

Symbol	Parameter	Conditions	Min	Typ	Max	Unit
$R_{th(j-mb)}$	thermal resistance from junction to mounting base		-	-	1.56	K/W

C_{th1}	4.740E-05 F
C_{th2}	3.573E-04 F
C_{th3}	2.573E-04 F
C_{th4}	9.872E-04 F
C_{th5}	2.798E-03 F
C_{th6}	7.463E-03 F
C_{th7}	2.715E-01 F
C_{th8}	3.781E+01 F
R_{th1}	1.715E-03 Ω
R_{th2}	3.454E-03 Ω
R_{th3}	3.886E-02 Ω
R_{th4}	1.014E-01 Ω
R_{th5}	3.814E-01 Ω
R_{th6}	8.981E-01 Ω
R_{th7}	1.681E-01 Ω
R_{th8}	5.350E-03 Ω

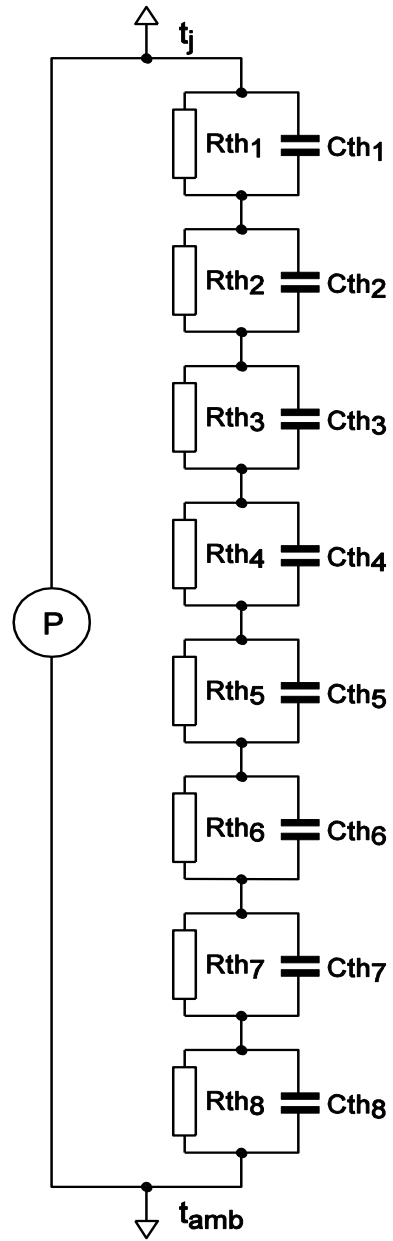

Part: BUK9515-60E
 Date: 17/4/2013
 Model Rth 1.60 K/W